

Ewon Cosy 131

INSTALLATION GUIDE

IG-0022-00 2.9 en-US ENGLISH



Important User Information

Disclaimer

The information in this document is for informational purposes only. Please inform HMS Networks of any inaccuracies or omissions found in this document. HMS Networks disclaims any responsibility or liability for any errors that may appear in this document.

HMS Networks reserves the right to modify its products in line with its policy of continuous product development. The information in this document shall therefore not be construed as a commitment on the part of HMS Networks and is subject to change without notice. HMS Networks makes no commitment to update or keep current the information in this document.

The data, examples and illustrations found in this document are included for illustrative purposes and are only intended to help improve understanding of the functionality and handling of the product. In view of the wide range of possible applications of the product, and because of the many variables and requirements associated with any particular implementation, HMS Networks cannot assume responsibility or liability for actual use based on the data, examples or illustrations included in this document nor for any damages incurred during installation of the product. Those responsible for the use of the product must acquire sufficient knowledge in order to ensure that the product is used correctly in their specific application and that the application meets all performance and safety requirements including any applicable laws, regulations, codes and standards. Further, HMS Networks will under no circumstances assume liability or responsibility for any problems that may arise as a result from the use of undocumented features or functional side effects found outside the documented scope of the product. The effects caused by any direct or indirect use of such aspects of the product are undefined and may include e.g. compatibility issues and stability issues.

Table of Contents

Page

1	Preface	3
1.1	About This Document	3
1.2	Document History	3
1.3	Related Documents	3
1.4	Trademark Information	3
2	Product Summary.....	4
2.1	Concept of the Ewon Cosy 131	4
2.2	Hardware General Specification.....	4
2.3	Typical Applications.....	4
2.4	Type & Part Numbers	4
3	Safety, Environmental & Regulatory Information	5
3.1	Scope.....	5
3.2	Power Supply	5
3.3	Applicable Directives, Standards and Compliance	5
3.4	Field Implementation & Environmental Conditions	6
3.5	Internal Battery	10
4	Hardware Description	11
4.1	Label.....	11
4.2	Mechanical Dimensions.....	13
4.3	Overall Description.....	13
4.4	Radio Communication Models.....	15
4.5	LAN Switch Specifications	20
5	IP Address & Access to the Web Configuration.....	22
5.1	Factory Default IP Settings.....	22
5.2	Powering On	22
5.3	Connecting to the LAN IP Address	22
5.4	Ewon Cosy 131 Web Interface	22
6	Troubleshooting	23
6.1	Normal Boot Process	23
6.2	Resetting the Ewon Cosy 131	23
6.3	Impact Matrix of a Reset	24
A	Connector Pinout & Related Specifications	25
A.1	Main Connector.....	25

B Specification of the External Power Supply 26

C Digital Output & Digital Inputs 27

 C.1 Possible Features 28

D Supported Wireless Wi-Fi Frequencies 29

E Deprecated Products 30

 E.1 Ewon Cosy 131 with Internal 4G JP Quad-band Modem (EC6133E_00MA) 30

1 Preface

1.1 About This Document

The present Installation Guide describes the hardware of the Ewon Cosy 131 which is an industrial gateway / router fully compatible with the [Talk2M cloud connectivity services](#).

For additional related documentation and file downloads, please visit www.ewon.biz/support.

1.2 Document History

Version	Date	Description
1.0	2015-01-22	First release
1.1	2015-02-04	Modified: Multiples pictures
1.2	2015-04-27	Modified: Wi-Fi & DI / DO
1.3	2015-06-30	Added: Cabling rules
1.4	2015-11-17	Added: LAN Switch specifications
1.5	2016-01-11	Modified: DO diagram
1.6	2016-06-14	Added: Cosy EC6133E Modified: Digital I/O
1.7	2016-07-27	Modified: Legal References
1.8	2017-09-07	Modified: General Template Modified: Cosy 131 Labels
1.9	2017-09-27	Modified: Applicable Safety Standards, p. 5
2.0	2018-03-02	Modified: Picture in Digital Output & Digital Inputs, p. 27
2.1	2018-04-17	Added: 4G models (EU & NA)
2.2	2018-05-03	Modified: Safety, Environmental & Regulatory Information, p. 5
2.3	2018-07-30	Modified: Safety, Environmental & Regulatory Information, p. 5
2.4	2018-09-03	Added: NCC Taiwan Certification
2.5	2018-10-05	Added: 4G model (APAC)
2.6	2019-06-25	Changed: Frequencies for 4G APAC model
2.7	2019-08-20	Changed: Safety, Environmental & Regulatory Information, p. 5 Changed: Hardware Description, p. 11
2.8	2020-01-20	Changed: Added RMC logo for Australia / New Zealand certification, Label, p. 11
2.9	2020-01-04	Added: Deprecated Products, p. 30

1.3 Related Documents

Document	Author	Document ID
eBuddy	HMS	AUG-0063-00
General Reference Guide for Cosy 131	HMS	RG-0010-00

1.4 Trademark Information

Ewon® is a registered trademark of HMS Industrial Networks SA. All other trademarks mentioned in this document are the property of their respective holders.

2 Product Summary

2.1 Concept of the Ewon Cosy 131

There are 4 models of the Ewon Cosy 131, each proposing a different communication media:

- 4 Ethernet ports only, labeled as **Ewon Cosy 131 Ethernet**
- Wi-Fi & 4 Ethernet ports, labeled as **Ewon Cosy 131 Wi-Fi**
- Cellular 3G+ & 4 Ethernet ports, labeled as **Ewon Cosy 131 3G**
- Cellular 4G & 4 Ethernet port, labeled as **Ewon Cosy 131 4G**

2.2 Hardware General Specification

Characteristic	Value
Design	Industrial design (24 VDC power supply, DIN Rail mounting, extended temperature)
Processor	ARM 9
Clock	Backed up real time clock (RTC) Backup battery lifetime has 10 years expectancy
Ethernet Interface	LAN Ethernet port 10 / 100 Mbps
Digital Input	2
Digital Output	1
Mounting	Latch for DIN rail EN50022-compliant

2.3 Typical Applications

The Ewon Cosy 131 can be used

- for remote access of Ethernet and / or USB devices using Talk2M connection
- as an industrial VPN router

The Ewon Cosy 131 should **not** be used

- as a pure Ethernet switch

2.4 Type & Part Numbers

The Ewon Cosy 131 is tagged following these part numbers:

Part number	Type	Description
EC61330_00MA	Ewon Cosy 131	LAN / WAN – 4 Ethernet ports only
EC6133C_00MA	Ewon Cosy 131	LAN / WAN, Wi-Fi – 4 Ethernet ports
EC6133D_00MA	Ewon Cosy 131	LAN / WAN, 3G+ penta-band – 4 Ethernet ports
EC6133E_00MA	Ewon Cosy 131	LAN / WAN, 4G quad-band – 4 Ethernet ports for Japan only This product is deprecated.
EC6133F_00MA	Ewon Cosy 131	LAN / WAN, 4G quad-band – 4 Ethernet ports for Asia & Pacific only
EC6133G_00MA	Ewon Cosy 131	LAN / WAN, 4G quad-band – 4 Ethernet ports for Europe only
EC6133H_00MA	Ewon Cosy 131	LAN / WAN, 4G quad-band – 4 Ethernet ports for North America only

The part number syntax is explained in details in the [Label, p. 11](#) section.



The **MA** at the end of the part number stands for “Multiple languages A” which regroups English, French, German, Italian and Spanish.

3 Safety, Environmental & Regulatory Information

3.1 Scope

This chapter addresses safety, environmental & regulatory information for the Ewon Cosy 131.

3.2 Power Supply

The external power supply is a third party device that is not part of this certification.

The device shall be powered by an LPS power supply certified according to IEC/UL60950-1 or Class2 per NEC or by a 12-24Vdc 100w max. certified for 60°C and for altitudes up to 2000m for conformity to the UL/IEC 62368-1 (for more information, refer to [Specification of the External Power Supply, p. 26](#)).

3.3 Applicable Directives, Standards and Compliance

The product described in the present Installation Guide complies with the CE, RE directives and the FCC regulations related to the wireless modems.

It also belongs to Class A Information Technology Equipment (ITE). In a domestic environment, this product may cause radio interference in which case the user may be required to take appropriate measures

3.3.1 Taiwan Regulatory Information

低功率電波輻射性電機管理辦法

第十二條 經型式認證合格之低功率射頻電機，非經許可，公司、商號或使用者均不得擅自變更頻率、加大功率或變更原設計之特性及功能。

第十四條 低功率射頻電機之使用不得影響飛航安全及干擾合法通信；經發現有干擾現象時，應立即停用，並改善至無干擾時方得繼續使用。前項合法通信，指依電信法規規定作業之無線電通信。低功率射頻電機須忍受合法通信或工業、科學及醫療用電波輻射性電機設備之干擾。

3.3.2 Applicable European Directives

The product described in the present Installation Guide is in conformity with the following EC directives:

- RoHS Directive 2011/65/EU
- EMC Directive 2014/30/EU
- RE Directive 2014/53/EU (for versions including RF modems)
The product conforms to the corresponding RE-D articles: RF Spectrum efficiency, Art. 3(2); EMC, Art. 3(1)(b); Safety, Art 3(1)(a).
- REACH Regulation 1907/2006

3.3.3 Applicable Safety Standards

The Cosy 131 is in conformity with the following safety standards:

- UL/IEC 62368-1
- CAN/CSA-C22.2 No 62368-1-14

The Ewon Cosy 131 is designed to work with an indoor antenna. It is the customer's responsibility to take all the necessary additional precautions in case the antenna is being extended to an external use with exposure to TNV voltages.

3.3.4 FCC Compliance

The product described in the present Installation Guide complies with Part 15 of the FCC Rules. Operating is subject to the following 2 conditions:

- This device may not cause harmful interference
- This device must accept any interference received, including interference that may cause undesired operation.

3.3.5 Certifications

The product described in the present Installation Guide complies with part 15 of the FCC Rules. Operating is subject to the following 2 conditions:

- UL Certificate Of Compliance (CoC) for Ordinary Locations #E350576 for a TMRA of 70°C
- CB Certificate #DK-72992-UL

These certificates can be downloaded as PDF files on the [Ewon Support website](#).

3.4 Field Implementation & Environmental Conditions

3.4.1 General Restriction

This equipment is not suitable for use in locations where children are likely to be present.

3.4.2 Ingress Protection

The Ewon Cosy 131 has an IP20 protection grade.

Therefore, the Ewon Cosy 131 is **NOT** suited for outdoor mounting. It has to be integrated in an electrical cabinet, protected from excessive heat, humidity and dust.

Do not push any sharp object into the air vents or openings of the equipment.

3.4.3 Mounting Recommendations

The product is intended to be mounted vertically, label on the right side.

The normal mounting position of the Ewon Cosy 131 is to be mounted on a horizontal [Omega type DIN-rail \(EN 50022\)](#).

- **Mounting the unit on DIN-rail**

Pull the slide lock (located at the bottom of the back-side of the unit) downwards and present the unit in front of the DIN rail. Tilt the Cosy 131 upwards in order to hang it on the upper edge of the DIN rail by its hook. Gently tilt the unit downwards until it finds its original position. Pull the slide lock upwards to fix and lock the unit on the DIN rail.

- **Removing the unit from DIN-rail**

Release the unit by pulling the slide lock downwards while gently tilting the unit upwards. Free the unit by unhooking it from the upper rail edge.

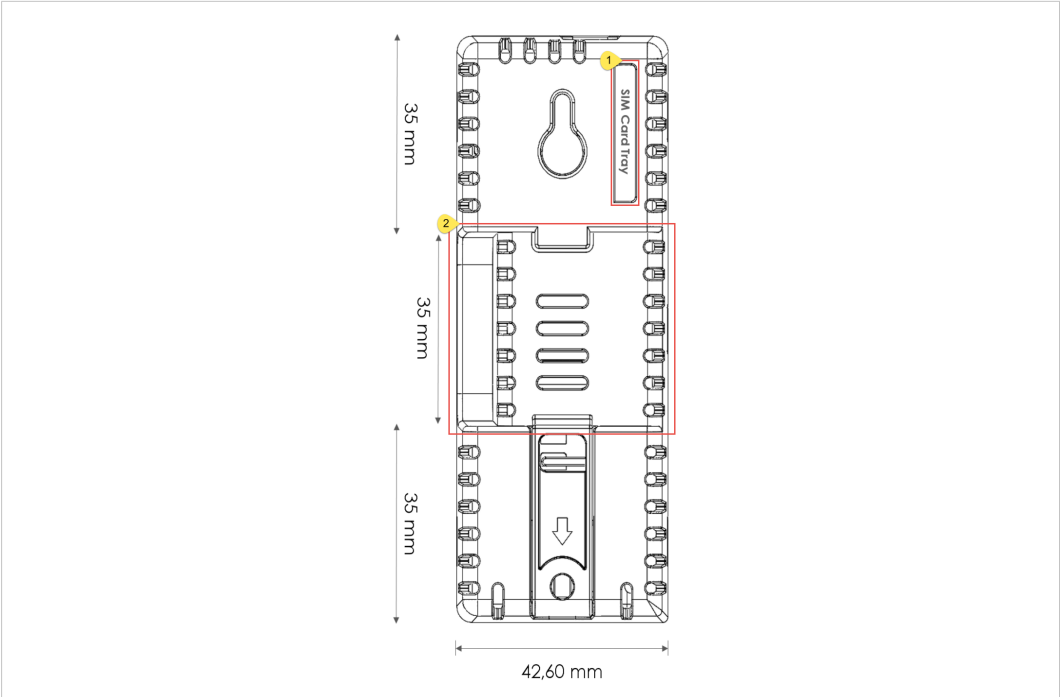

Fig. 1 DIN rail mounting position

#	Description
1	SIM card slot
2	DIN rail mounting bracket

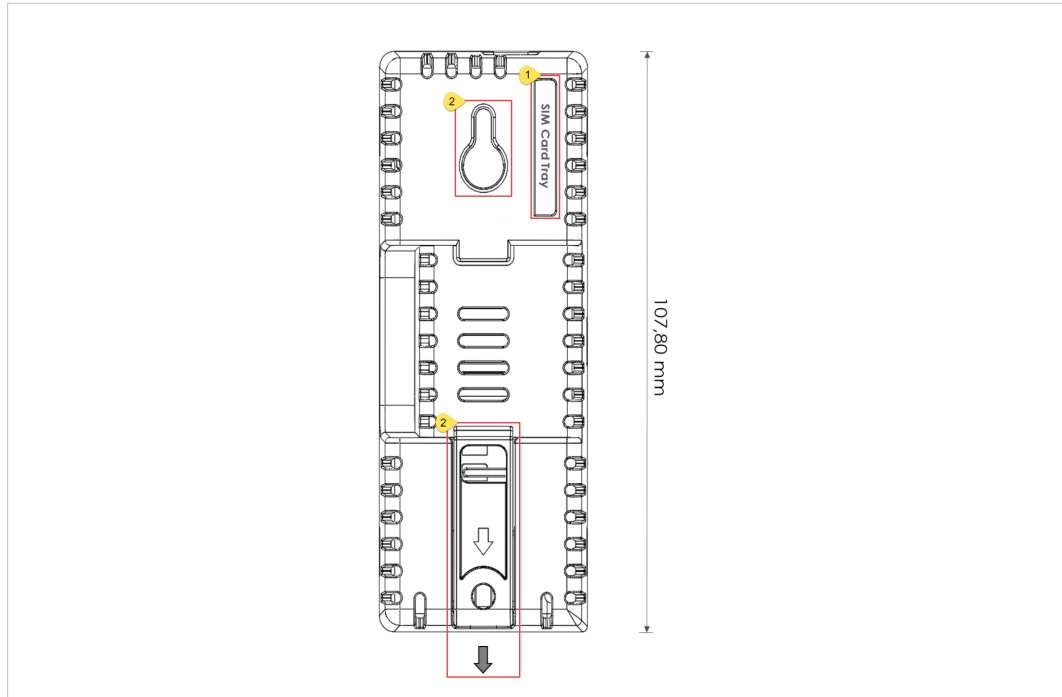

Fig. 2 Wall mounting position

#	Description
1	SIM card slot
2	Wall mounting bracket (suggested screw dimensions 4,2 x 32 mm)



Caution

Please set the screws in both wall mounting brackets to prevent accidents

To ensure a proper ventilation of the equipment, a free gap of at least 2 cm must be respected in front of all upper & lower ventilation openings of the unit.

A free gap of at least 1 cm must be respected on each side of the unit.

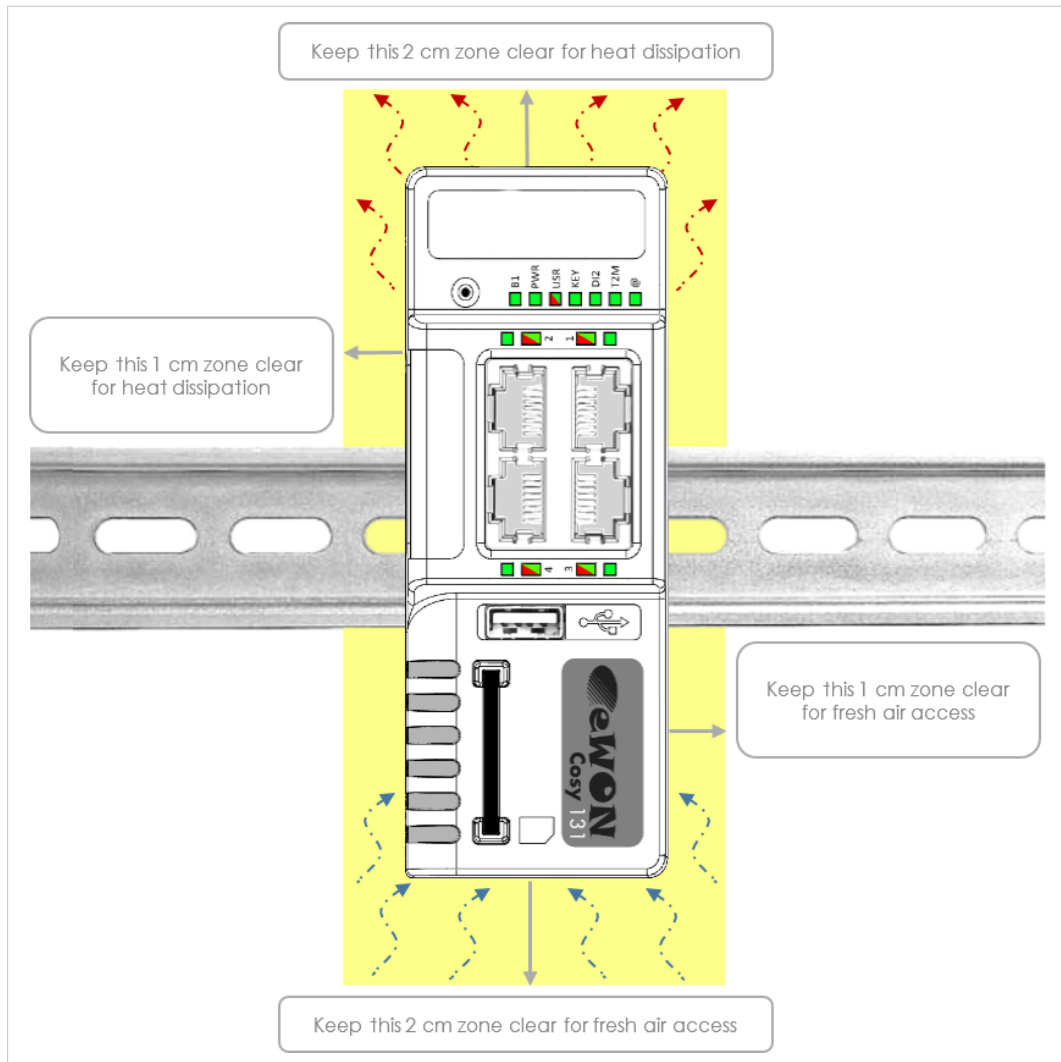

Fig. 3 Free gap surrounding the Ewon Cosy 131 for heat dissipation.

3.4.4 Cabling Rules

Shielded cables must be used for Ethernet and USB connectivity to comply with the EMC requirements.

USB cable must be:

- Shorter than 3m
- USB 2.0 type A (on Ewon Cosy 131 side)
- Minimum current per contact : 0.5A (or better)



Caution

To prevent accidentally pulling out wires, be sure that cables are firmly attached to wire connectors. For screw connectors, make sure that screws are properly tightened as well as routing the equipment wires separately from other high voltage wires.

3.4.5 Environmental Conditions

The equipment operates properly within the following environmental limits if it has been correctly mounted according to the above mentioned recommendations:

Operating Temperature	-25°C to +70°C
Relative Humidity	10 to 95% non-condensing
Operating Altitude	Up to maximum 2000m
Storage Temperature	-40°C to +70°C
Storage Humidity	10 to 95% non-condensing
Storage Altitude	Up to maximum 3000m



In any other mounting position than the one explained above, the specified operating temperature has to be derated to -25°C to +40°C.

3.4.6 Earthing

Earthing the Cosy 131 is necessary to eliminate unwanted transients and to conform to the EMC requirements. Therefore, a functional earth (FE) terminal is available on the main connector as shown in [Specification of the External Power Supply, p. 26](#).

Connect this terminal directly to allow impedance ground. Shielded cables have to be used for Ethernet and USB to comply with the EMC requirements.

3.5 Internal Battery

The Ewon Cosy 131 contains a CR2032 battery. This battery is used to maintain the real time clock up-to-date even when the unit is not powered.

Here is a list of risks and recommendations regarding the battery:

- Risk of explosion if the battery is replaced by an incorrect type. The battery is not intended to be replaced by the consumer: the product shall be returned to the manufacturer for replacement.
- Do not ingest battery, chemical burn hazard.
- Keep new and used batteries away from children.
- If the cell battery is swallowed, it can cause several internal burns in just 2 hours and can lead to death.
- If the equipment's enclosure do not close securely, stop using the product and keep it away from children.
- If you think batteries might have been swallowed or placed inside any part of the body, seek immediate medical attention.

4 Hardware Description

4.1 Label





The identification label of the Ewon Cosy 131 is placed on the right hand side of the housing. The different parts of the label are described hereunder:

Label	Description
PN	Part Number (see syntax table below)
SN	Serial Number in the form: YYWW-SSSS-PP <ul style="list-style-type: none"> YY : Year of production WW : Week of production SSSS : Sequential manufacturing order PP : Product type
MAC	MAC address of the Ethernet adapter
Rating	Power supply requirements
Marks	CE, UL... logos if applicable



Fig. 4 Ewon Cosy 131 — 4 ports Ethernet: Label

The applicable marks on the Ewon Cosy 131 are the following:

Marks	Description
	Conformité Européenne or European Conformity (EC)
	UL Listed — Underwriters Laboratories
	GITEKI (MIC) — Radio Act Conformity Mark
	RCM

The label can have variant marks depending on the model of the Cosy 131.



Ewon Cosy 131 — Ethernet label



Ewon Cosy 131 — Wi-Fi label



Ewon Cosy 131 — 3G+ penta-band label



Ewon Cosy 131 — 4G APAC label



Ewon Cosy 131 — 4G EU label



Ewon Cosy 131 — 4G NA label

The following table explains the Part Number syntax:

EC6133m_ccLL[suffix]			
Position(s)	Description	Acceptable values	
EC	Name of product family	EC for Ewon Cosy 131	
6	Number corresponding to the hardware platform	6	Cosy 131 platform
1	Communication options 1	1	1 Ethernet
3	Communication options 2	3	3 Ethernet
3	Field communication option	3	USB
m	Modem communication option	0	No modem
		C	Wi-Fi
		D	3G+ modem
		E, F, G, H	4G modem Respectively Japan, Asia-Pacific, Europe, North America
cc	Contains one or more characters (digits and/or letters)	00 = no software option	
LL	Defines the firmware language	MA	Regroups EN, FR, DE, ES and IT
[suffix]	Optional “ / ” character Defines the compliances of the unit	S	compliance with the UL / IEC / EN 60950 standard

4.2 Mechanical Dimensions

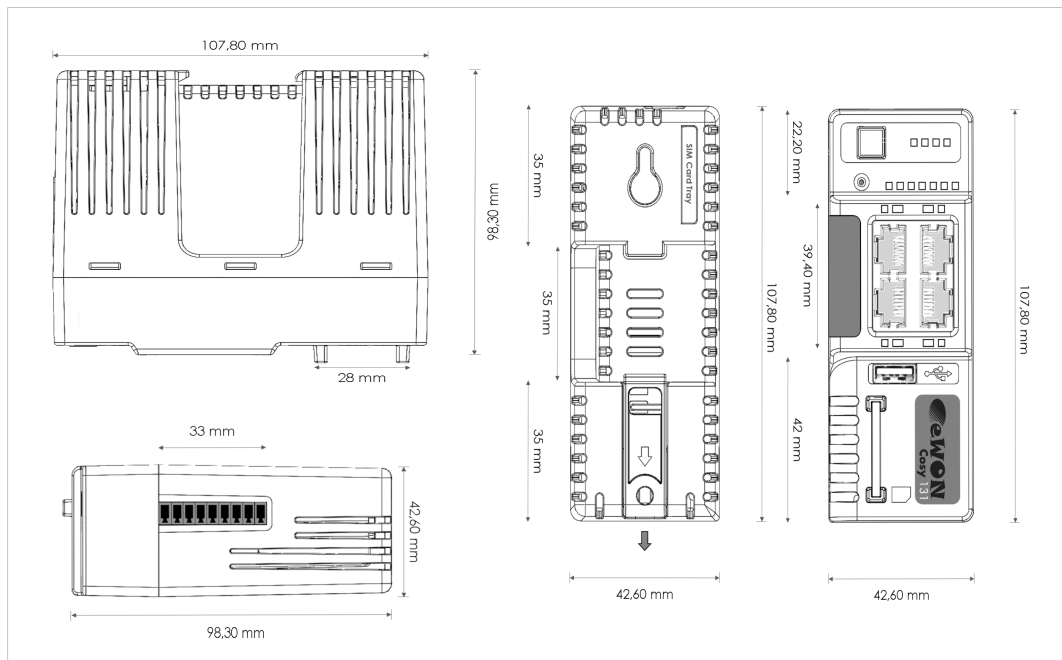

Fig. 5 Mechanical dimensions of the Ewon Cosy 131

4.3 Overall Description

4.3.1 Front

#	Description
1	Reset button
2	Status LEDs
3	LAN / WAN Ethernet ports and corresponding status LEDs (Red: WAN and Green: LAN)
4	USB slot
5	SD card slot

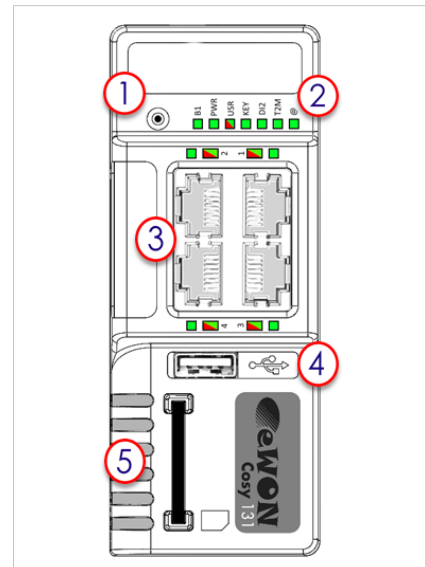

Fig. 6 Front panel

4.3.2 Upper Side

#	Description
1	Main connector including power input terminal, 1 DO and 2 DI

For more information about the connector, refer to [Main Connector, p. 25](#)

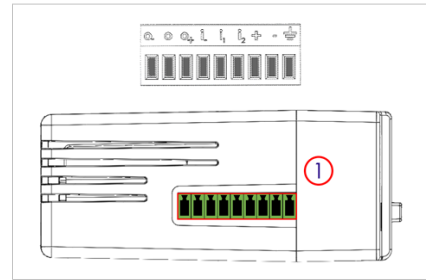

Fig. 7 Main connector and associated plug

4.3.3 Status LED

All Versions

Label	Description
BI1	Button BI1 input Steady green = reset button is being pressed
PWR	Power Steady green = unit is powered on
USR	User Blinking green slowly = Unit is ok Red pattern = special attention required
KEY	Digital IN 1 See Digital Output & Digital Inputs, p. 27 Green = ON : Signal on Input 1 detected
DI2	Digital IN 2 See Digital Output & Digital Inputs, p. 27 Green = ON : Signal on Input 2 detected
T2M	Talk2M See Digital Output & Digital Inputs, p. 27 Green = ON : Talk2M VPN connection established
@	Internet Steady green = Internet is configured on the Ewon Cosy 131

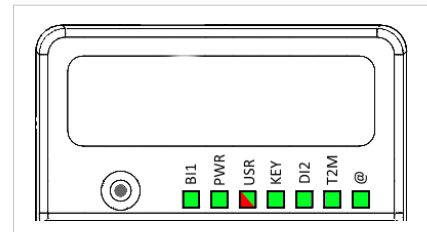

Fig. 8 Status LEDs representation — All versions

Wi-Fi Version (EC6133C)

#	Mark	Description
1	/	RP-SMA female connector for Wi-Fi antenna
2	ST	Modem status Steady green = Wi-Fi connected
3	■	Reception signal level Steady orange = Poor signal
4	■ ■	Reception signal level Steady orange = Signal is OK
5	■ ■ ■	Reception signal level Steady orange = Signal is good

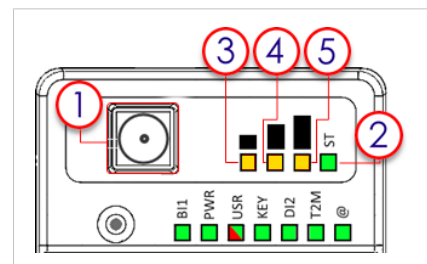

Fig. 9 Status LEDs representation – Wi-Fi model

Cellular Version (EC6133D, EC6133E, EC6133F, EC6133G & EC6133H)

#	Mark	Description
1	/	SMA female connector for GSM antenna
2	ST	Modem status Steady green = Modem connected
3	■	Reception signal level Steady orange = Poor signal
4	■ ■	Reception signal level Steady orange = Signal is OK
5	■ ■ ■	Reception signal level Steady orange = Signal is good

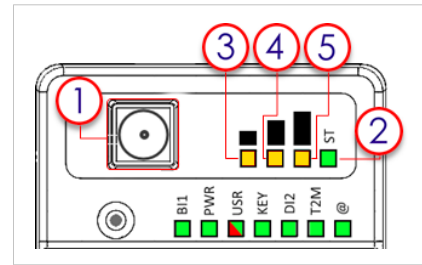

Fig. 10 Status LEDs representation — Cellular model

4.4 Radio Communication Models

! This device is intended to be used in fixed or mobile applications only (not for portable applications).

! The antenna used for this transmitter has to be installed in a space providing a safe distance of at least 20 cm without encountering anyone and must not be collocated or operating in conjunction with any other antenna or transmitter.

4.4.1 Ewon Cosy 131 with Internal Wi-Fi Model (EC6133C_00MA)

Item	Value(s)			
Protocols and frequencies	IEEE802.11b/g/n, 2.4GHz - Channels: 1 to 11(inclusive)			
Antenna connector	Type RP-SMA			
Antenna (included in the delivery)	Character	Value(s)		
	Impedance	50 Ohms		
	Input power	802.11b/g/n	2.4Ghz	19dBm
	Tightening torque	0.5 Nm ¹		

Device conformity has been tested with the reference antenna: Pulse W1030.

Additional information:

- The product complies with the RE directive, the FCC, the IC and Japan regulations related to the Wi-Fi communications.
- Absolute maximum antenna gain as per FCC's rules and regulations, 47CFR:
 - Part 15C : 2.14dBi
- Modifications cannot be made by the user if it influences the normal behavior of the device.
- This product contains part identified as follows by national authorities:
 - FCC ID: QQQWF111
 - IC ID: 5123A-BGTWF111
 - RRA ID: KCC-CRM-BGT-WF111
 - GITEKI (MIC) ID: 209-J00061

1. In the absence of a torque wrench, a soft manual tightening is sufficient.

4.4.2 Ewon Cosy 131 with Internal 3G+ Penta-band Modem (EC6133D_00MA)

Item	Value(s)	
Protocols and frequencies	GSM/GPRS/EDGE - 850, 900, 1800, 1900 MHz UMTS/HSUPA - 800/850, 900,AWS 1700,1900,2100 Mhz	
Class	Penta-band GPRS / EDGE Class 33	
Antenna connector	Type SMA	
Antenna (not included in the delivery)	Character	Value(s)
	Impedance	50 Ohms
	VSWR	<= 5:1 Absolute maximum to avoid permanent damage <= 2:1 Limit to fulfill all regulatory requirements
	Input power	> 33 dBm (2W) peak power in GSM > 24 dBm average power in WCDMA
	Tightening torque	0.5 Nm ²

Device conformity has been tested with the reference antenna: Taoglas TG.09.0113³.



As seen in [Mounting Recommendations](#), p. 6, SIM card tray is located at the rear of the Ewon Cosy 131.

Additional information:

- The product complies with the RE directive, the FCC, the IC and Japan regulations related to the GSM modems.
- Absolute maximum antenna gain as per FCC's rules and regulations, 47 CFR :
 - Part 22H : 5.22dBi
 - Part 27 : 3.31dBi
 - Part 24E : 6.45dBi
- Modifications can't be made by the user if it influences the normal behavior of the device.
- This product contains part identified as follows by national authorities:
 - FFC ID: RI7HE910
 - IC ID: 5131A-HE910
 - GITEKI (MIC) ID: 005-100269
 - JATE ID: AD12-0318001

2. In the absence of a torque wrench, a soft manual tightening is sufficient.

3. 3G antenna has to be purchased separately. HMS Industrial Networks SA offers such antenna under "FAC90501_0000" reference.

4.4.3 Ewon Cosy 131 with Internal 4G APAC Quad-band Modem (EC6133F_00MA)

Item	Value(s)	
Protocols and frequencies	LTE: B1, B3, B5, B7, B8, B18, B19, B21, B28, B38,B39, B40, B41 UMTS: B1, B5, B6, B8, B9, B19,B39	
Antenna connector	Type SMA	
Antenna (not included in the delivery)	Character	Value(s)
	Impedance	50 Ohms
	VSWR	<= 3:1 Absolute maximum limit <= 2:1 Limit to fulfill all regulatory requirements
	Input power	> 33 dBm (2W) peak power in GSM > 24 dBm average power in WCDMA
Tightening torque	0.5 Nm. <i>In the absence of a torque wrench, a soft manual tightening is sufficient.</i>	

Device conformity assessment has been performed with the reference antenna: Taoglass G.30.B108111 ⁴.

 As seen in [Mounting Recommendations, p. 6](#), SIM card tray is located at the rear of the Cosy 131.

Additional information:

- The product complies with the Japanese regulations related to the GSM modems.
- Modifications cannot be made by the user if it influences the normal behavior of the device.
- This product contains part identified as follows by Japanese authorities:
 - Radio Act (GITEKI (MIC) ID): 003-160025
 - Telecom Act (JATE ID): AD16-0014003

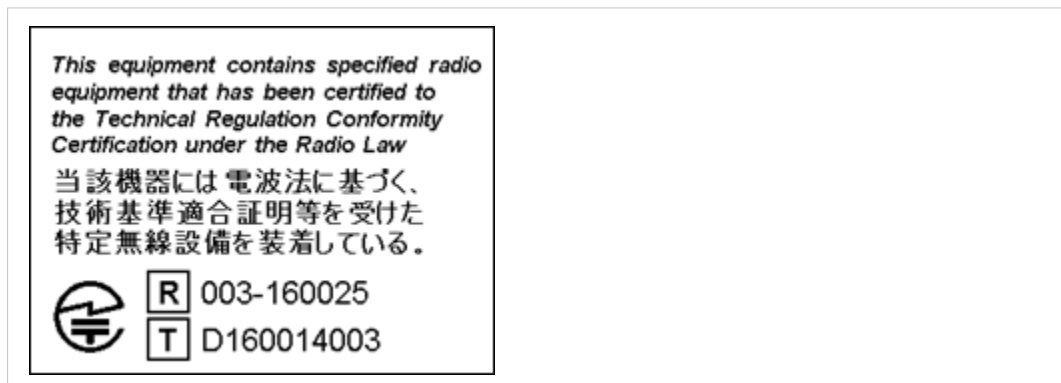

Fig. 11 Radio equipment certification for Ewon Cosy 131 — 4G APAC modem

4. 4G antenna has to be purchased separately. HMS Industrial Networks SA offers such antenna under "FAC90801_0000" reference.

4.4.4 Ewon Cosy 131 with Internal 4G EU Quad-band Modem (EC6133G_00MA)

Item	Value(s)	
Protocols and frequencies	LTE: 800MHz (B20), 900MHz (B8), 1800MHz (B3), 2100MHz (B1), 2600MHz (B7); UMTS/HSUPA: 900Mhz (B8), 2100MHz (B1);	
Antenna connector	Type SMA	
Antenna (not included in the delivery)	Character	Value(s)
	Impedance	50 Ohms
	VSWR	<= 2:1
	Input power	> 24 dBm average power
	Tightening torque	0.5 Nm. <i>In the absence of a torque wrench, a soft manual tightening is sufficient.</i>

Device conformity assessment has been performed with the reference antenna: Panorama B4BE-7-27 ⁵.



As seen in [Mounting Recommendations](#), p. 6, SIM card tray is located at the rear of the Ewon Cosy 131.

Additional information:

- The product complies with the RE directives related to the GSM modems.
- Modifications cannot be made by the user if it influences the normal behavior of the device.

⁵ 4G antenna has to be purchased separately. HMS Industrial Networks SA offers such antenna under "FAC90901_0100" or "FAC90901_0000" reference.

4.4.5 Ewon Cosy 131 with Internal 4G NA Quad-band Modem (EC6133H_00MA)

Item	Value(s)	
Protocols and frequencies	LTE: 00MHz (B12/B13), 850MHz (B5), 1700MHz (B4), 1900MHz (B2) UMTS/HSPA: 850MHz (B5), 1900MHz (B2)	
Antenna connector	Type SMA	
Antenna (not included in the delivery)	Character	Value(s)
	Impedance	50 Ohms
	VSWR	<= 2:1
	Input power	> 24 dBm average power
	Tightening torque	0.5 Nm. <i>In the absence of a torque wrench, a soft manual tightening is sufficient.</i>

Device conformity assessment has been performed with the reference antenna: Panorama B4BE-7-27⁶.



As seen in [Mounting Recommendations](#), p. 6, SIM card tray is located at the rear of the Ewon Cosy 131.

Additional information:

- The product complies with the FCC, the IC regulations related to the GSM modems.
- Absolute maximum antenna gain as per FCC's rules and regulations, 47 CFR :
 - Part 22H : 5.22dBi
 - Part 27 : 3.31dBi
 - Part 24E : 6.45dBi
- Modifications cannot be made by the user if it influences the normal behavior of the device.
- This product contains part identified as follows by national authorities:
 - FCC ID: RI7LE910NAV2
 - IC ID: 5131A-LE910NAV2

4.5 LAN Switch Specifications

4.5.1 Boot Process

After powering on or requesting a reboot of the Ewon Cosy 131, a wait is required to get the LAN switch feature fully operational. (approximately 45 sec).



The ultimate decision the Cosy 131 takes when it can no more run a given configuration is to reboot itself. This aims at restoring the requested communication channels and being consistent with the requested configuration.

6. 4G antenna has to be purchased separately. HMS Industrial Networks SA offers such antenna under "FAC90901_0100" or "FAC90901_0000" reference.

4.5.2 LAN Switch Configuration

At the very first boot or after a reset level 2, the Ethernet ports scheme will be configured as follows:

- Port #1 : LAN
- Port #2 : LAN
- Port #3 : LAN
- Port #4 : WAN

The Ethernet ports functionality can be configured as wanted except for the port #1 which always remains in LAN mode.



Ethernet port #1 must be used for maintenance operation such as update or recovery process.

5 IP Address & Access to the Web Configuration

5.1 Factory Default IP Settings

Characteristics	Values
LAN IP address	10.0.0.53
LAN subnet mask	255.255.255.0
Gateway	0.0.0.0



Since firmware version 10, the WAN IP address is set by default in DHCP mode.

5.2 Powering On

Power on the unit and wait approximately 45 seconds until the boot process is completed.

After a successful boot process the **USR** LED is blinking green slowly.

If the **USR** LED is blinking red according to a given pattern, it indicates that the boot process was interrupted due to a problem. The most frequent problem is :

- a duplicate IP address was detected on the LAN network: **USR** LED blinking pattern is red 1x short, 1x long

For other error LED patterns, please refer to the General Reference Guide for Cosy 131 from the [Related Documents, p. 3](#).

5.3 Connecting to the LAN IP Address

Establish the first communication with the Ewon Cosy 131 by using Ewon Cosy 131 companion tool **eBuddy** which can be downloaded from www.ewon.biz/support.

Connect a LAN port (port #1 is always set as a LAN port) of the Ewon Cosy 131 to one's computer either through a point-to-point connection or a network where there is no risk Cosy 131's default IP address (10.0.0.53) would conflict with another connected device.

5.4 Ewon Cosy 131 Web Interface

While the computer is connected to a LAN port of the Ewon Cosy 131, open an Internet browser and reach the Ewon Cosy 131 web server whose URL is the LAN IP address of the Cosy 131.

Another way to access the web panel of the Cosy 131 is by using eBuddy. To get started with eBuddy and access the Cosy 131, refer to the eBuddy of the [Related Documents, p. 3](#).

At the very first boot of the Cosy 131 or after a level 2 reset, an interface language selection will be proposed.

Before beginning the configuration of the Cosy 131, an authentication is required.



Default login & password are both *adm*. For security reasons, default password **must** be modified.

A configuration wizard will be proposed afterwards which sets the configuration of the Ewon Cosy 131 but also the connection to the Talk2M environment.

On our website, a [Quick Start Guide](#) can be found which helps in the configuration of the Ewon Cosy 131

6 Troubleshooting

6.1 Normal Boot Process

The normal boot process of the Ewon Cosy 131 takes approximately 25 seconds to complete. During this process, all LEDs are first shortly on (except **BI1**) then only the **PWR** LED stays steady green.

As soon as the boot process is completed and the unit is ready to be used, the **USR** LED blinks green slowly whereas others might be steady green (if the device is connected to Internet, Talk2M...).

6.2 Resetting the Ewon Cosy 131

The reset button **BI1** is located on the front of the Cosy 131 (see [Front, p. 13](#)). The reset function of this button is active only if pressed while powering on.

The Ewon Cosy 131 features two levels of reset:

6.2.1 First Reset Level: User Reset

The first reset level is a selective reset that erases the user files part and the system settings. This type of reset does not alter the communication parameters of the Ewon Cosy 131.

Hereunder is the process to perform a first reset level:

- Power off the unit.
- While powering it on, press & maintain the reset button. The LED labeled **BI1** turns green.
- Keep the reset button pressed for approximately 30 seconds until the **USR** LED blinks red 1x per second. If it isn't released at that specific moment, a second level reset phase is initiated. The LED labeled **BI1** turns off.
- Wait approximately 30 seconds until the reset process is completed.
- The Cosy 131 automatically restarts and the unit is ready to be used, the **USR** LED blinks green slowly.

6.2.2 Second Reset Level: Factory Reset

The second level reset restores the Cosy 131 to its factory settings. This operation consists in 3 steps:

- Format the entire non volatile memory, including all COM parameters and IP addresses
- Full hardware auto-test with result shown by the **USR** LED
- Return to ex-factory configuration (default configuration)

Hereunder is the process to perform a second reset level:

- Power off the unit.
- While powering it on, press & maintain the reset button. The LED labeled **BI1** turns green.
- Keep the reset button pressed for approximately 35 seconds until the **USR** LED remains red steady.
- When this state is reached, release the button. The LED labeled **BI1** turns off.
- Check if the auto test is successful, the **USR** LED blinks red with a pattern of 200ms on and 1500ms off. The Cosy 131 does NOT restart by itself in normal mode and remains running in this diagnostic mode.

- Power off the Ewon Cosy 131 and power it on again to reboot the unit in a normal mode. As described before, the Cosy 131 returns to its default COM parameters and factory IP addresses (such as LAN 10.0.0.53) after this level 2 reset is performed.

Any other LED pattern reflects a problem. The pattern will start with 200ms on (start of the pattern) followed by off and a certain number of times of a 1 second on allowing to identify the nature of the detected problem. If an error pattern occurs on the **USR** LED, please check out the troubleshooting page: www.ewon.biz/support

6.3 Impact Matrix of a Reset

Reset level	Erased or Reset	Preserved
Impact of a reset level 1 User reset	adm password	LAN IP address + mask
	Cosy 131 identification	Internet access
	User web site	Language settings
		Modem / Wi-Fi settings
		Talk2M configuration
		Proxy configuration
		LAN switch configuration
	Gateway (USB, NAT 1:1) ⁷	
Impact of a reset level 2 Factory reset	The Ewon Cosy 131 will be reset to a factory settings configuration. All parameters will be lost	

7. Configuration remains even if the Wizards on Ewon web interface indicates otherwise

A Connector Pinout & Related Specifications

A.1 Main Connector

As shown in the below picture, the female mating connector is labeled with the appropriate symbols.

Characteristic	Value
Connector type	MINICONNEC MC model Type MC 1.5 / 9-ST-3.5 Pitch = 3.50mm 9-pin female
Maximal tightening torque	0.25Nm <i>In the absence of a torque wrench, a soft manual tightening is sufficient</i>

PIN	ICON	ID	Description
1	O.	DO_COM	Output signal (0V ground) connected to the emitter of the MOSFET transistor
2	O	DO	Output signal connected to the drain of the MOSFET transistor
3	O ₊	DO_VDC	Common of the external predrive power supply (between +12 et +24 VDC)
4	I.	DI_COM	Ground of the input (isolated)
5	I ₁	DI1	Input signal 1
6	I ₂	DI2	Input signal 2
7	+	Power in VDD +	Between +12 and +24 VDC
8	-	Power in GND —	0V
9		Functional earth	

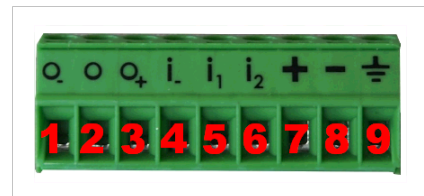

Fig. 12 Connector pinout

B Specification of the External Power Supply

The Ewon Cosy 131 must be powered by a 12-24Vdc 100w max. certified for 60°C and for altitudes up to 2000m for conformity to the UL/IEC 62368-1 or by a safety Low Power Supply (LPS) in accordance with clause 2.5 of UL/IEC 60950-1 Ed2. Standard, 12-24Vdc, 30W min. Certified for 70°C and for altitudes up to 2000m. The safety LPS power supply is not part of the delivery.

Suggested power supply : SIEMENS SITOP logo power 24V 2.5A 60W - Siemens order ref: 6EP1332-1SH43. Equivalents are available on the market.

Characteristics of the power supply can be found hereunder:

Characteristic	Value
Power supply voltage	External 12-24 VDC +/- 19%
Maximum Ewon Cosy 131 input power	30W maximum
Internal voltage protection	30V maximum
Input protection	Protected against polarity inversion

C Digital Output & Digital Inputs

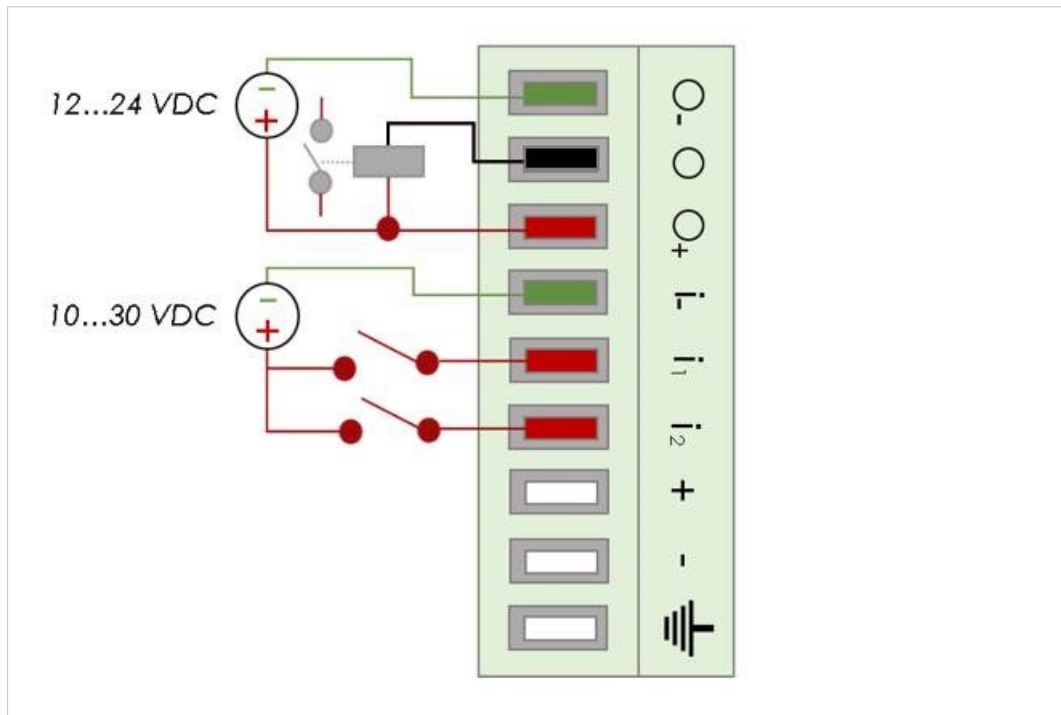

Fig. 13 Current scheme of the main connector

Characteristic	Value
Type of digital output ⁸	Open drain MOSFET
Maximum current (ext,source)	200 mA
Isolation (both DI & DO)	1.5 kV
DI voltage range	0 to 24 VDC
DI protection	33 VDC Max
DI OFF state — input voltage range	0 to 5 VDC
DI ON state — input voltage range	10 to 30 VDC
DI ON state — current range	From 3,8 mA @ 12 VDC to 8,2 mA @ 24 VDC

The Digital Output is activated by an open drain MOSFET transistor driven by an optocoupler. The maximum current flow inside this transistor has a value above the one specified in the Cosy 131, in order to cope with the switching power losses.

The transistor used is in an open drain type with predrive. This means the relay power supply has to be supplied from an external source to the predrive electronics.

The diagram below shows the external wiring needed for proper operation of the digital output. A relay has been chosen for this sample application but any load within the specifications can be used instead.



This is a sink only output to ground (the transistor acts as a switch ground).

8. During the starting boot process, the DO will be switched ON for a short time (2 seconds)

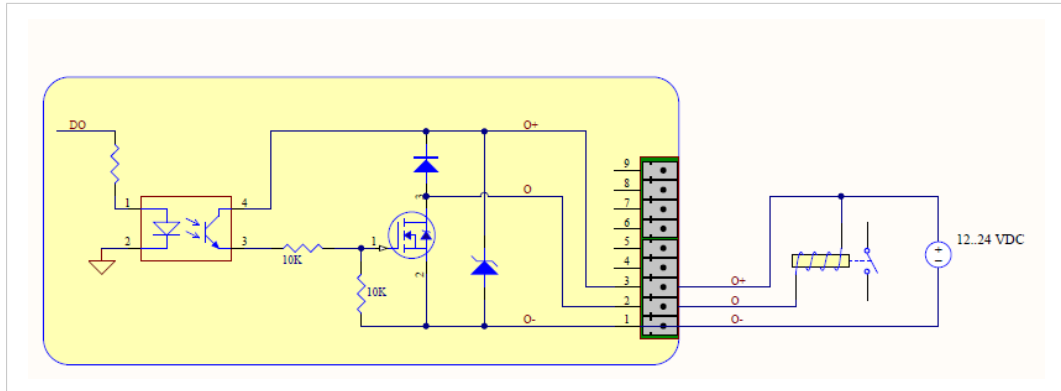

Fig. 14 External wiring for the Digital Output

C.1 Possible Features

Wiring the Digital Output & Inputs can be used to externalize some features (as connectivity condition) as described below:

LED	Connector	Description
KEY	DI1	Authorize or prevent the Internet connection.
		Authorize or prevent the VPN connection.
		Trigger an SMS or email notification.
DI2	DI2	Trigger an SMS or email notification.
T2M	DO	Can be wired to an external device to propagate the Talk2M status. If the VPN connection is active, the DO is set to 1.

The configuration of these conditions has to be done during the “DI Config” wizard which offers the opportunity whether the **Digital Input** should be used or not and for which purpose.

D Supported Wireless Wi-Fi Frequencies

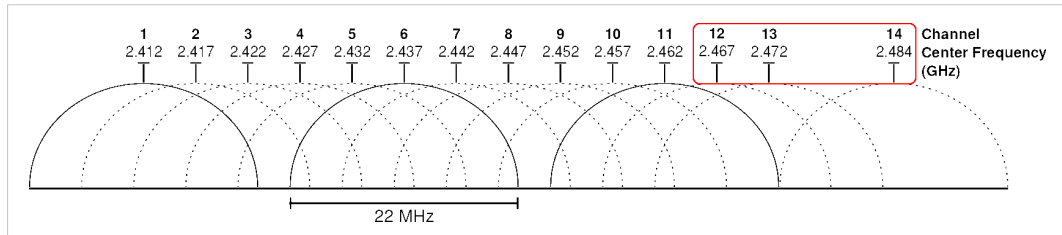

Fig. 15 Supported Wi-Fi frequencies

Supported channels frequencies are between channel 1 (2,412 Ghz) and channel 11 (2,462 Ghz).



Channels 12, 13 & 14 are not supported

E Deprecated Products

E.1 Ewon Cosy 131 with Internal 4G JP Quad-band Modem (EC6133E_00MA)



Fig. 16 Ewon Cosy 131 — 4G Japan label

Item	Value(s)	
Protocols and frequencies	LTE : 850MHz (B19), 1500MHz (B21), 2100MHz (B1) UMTS :800MHz (B6), 850MHz (B5, B19), 2100MHz (B1) GSM, EDGE, GPRS: 850MHz, 900MHz, 1800MHz, 1900MHz	
Antenna connector	Type SMA	
Antenna (not included in the delivery)	Character	Value(s)
	Impedance	50 Ohms
	VSWR	<= 3:1 Absolute maximum limit <= 2:1 Limit to fulfill all regulatory requirements
	Input power	> 33 dBm (2W) peak power in GSM > 24 dBm average power in WCDMA
Tightening torque	0.5 Nm. <i>In the absence of a torque wrench, a soft manual tightening is sufficient.</i>	

Device conformity assessment has been performed with the reference antenna: Taoglass G.30.B108111⁹.



As seen in [Mounting Recommendations](#), p. 6, SIM card tray is located at the rear of the Ewon Cosy 131.

Additional information:

- The product complies with the Japanese regulations related to the GSM modems.
- Modifications cannot be made by the user if it influences the normal behavior of the device.
- This product contains part identified as follows by Japanese authorities:
 - Radio Act (GITEKI (MIC) ID): 005-100567
 - Telecom Act (JATE ID): AD13-0163005

⁹ 4G antenna has to be purchased separately. HMS Industrial Networks SA offers such antenna under "FAC90801_0000" reference.

- This product contains part identified as follows by Australian / New Zealand authorities:
 - RCM: 03201



Fig. 17 Radio equipment certification for Ewon Cosy 131 — 4G JP modem

